

Electrical Spec

1 Resolution	7168CPR
2 Output	ABZ
3 Rated Voltage	5.0VDC ± 0.25V
4 Current Consumption	< 60mA
5 Output Form	Differential, RS422
6 Maximum Speed	12500 RPM

Mechanical Spec

7 Mass	6.2g
8 Storage Temp	-40°C --- +85°C
9 Operating Temp	-40°C --- +85°C

RECEIVING AND TRANSMITTING INTERFACE

Differential signal(RS-422):

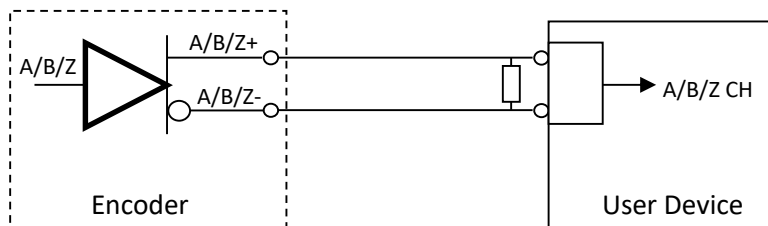

ABZ output phase shift

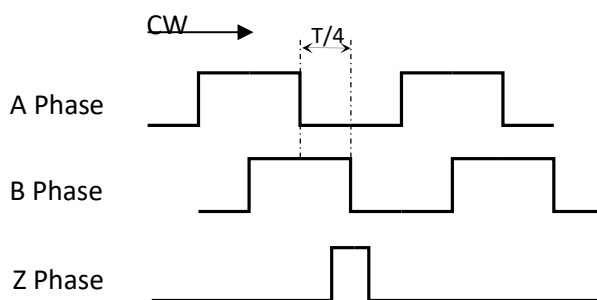

Dimensional drawing

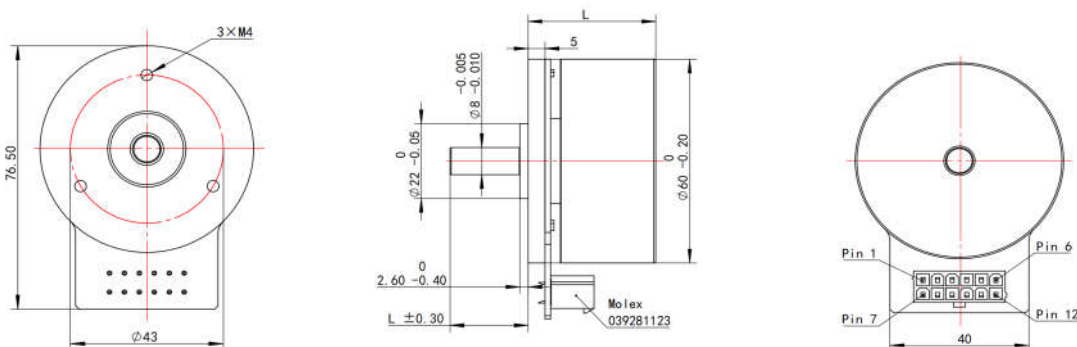

Option, cable and connection information

Connector Molex 039281123

Z+	Pin 1	+5VDC	Pin 7
B+	Pin 2	Z-	Pin 8
A+	Pin 3	B-	Pin 9
GND	Pin 4	A-	Pin 10
Motor winding 2	Pin 5	GND	Pin 11
Motor winding 3	Pin 6	Motor winding 1	Pin 12

Note:About the torque curves,please contact us for more information.
www.nuelectronics.com